

Convertible Bench Units



Heavy Duty

Industrial-grade 14-gauge square tubing legs and 16 gauge aprons.

Versatile

Designed to adapt and maximize space in any environment with multiple seating configurations

Compact

The easy fold mechanism and unique leg design allow for easy nesting

Convertible Bench Configurations

AUDITORIUM



TESTING



DINING



1 BENCH WITH
3 SYSTEM
CONFIGURATIONS

Convertible Bench Specifications

The **NPS Convertible Units** are perfect for a variety of uses. These multipurpose units easily set up in seconds. They can be used as a comfortable bench with a back or a table with a bench. The change is easy and fast. They can also be combined to make one large table using our included ganging devices. Tables and benches fold and nest beautifully for perfect storage.

STANDARD FEATURES



4 heavy-duty swivel casters, 2 locking



Create one large table using the included built-in ganging devices.



16-Gauge Aprons



Under Table Hat Support



"Pinch-proof" folding mechanism enables bench to fold without hitting tabletop



Heavy 14-gauge steel square tubing creates a strong, reliable table.



Non-marring reinforced nylon glides with steel inserts installed over leg uprights.



1,000 lbs. distributed weight capacity

EASY SET-UP, GANGING, AND STORAGE



Open



Flip



Gang



Storage

STANDARD LENGTHS

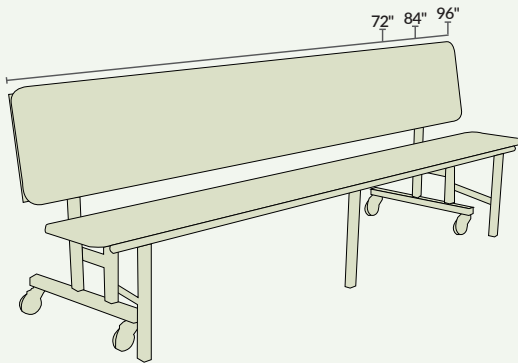

CORE OPTIONS



Plywood
.75" Premium Plywood
HPL Surface
3mm Hot-Melt PVC Edge



Particleboard
.75" Particleboard
HPL Surface
T-molding



MDF
.75" Medium Density Fiberboard
HPL Surface
Protect Edge

| MODEL # | DESCRIPTION | SEATS | TABLE WxL | FOLDED DIMENSIONS |
|---------|------------------------|-------|-----------|-------------------|
| CBG72 | 72"L Convertible Bench | 3-4 | 29"x72" | 72"x12"x34" |
| CBG84 | 84"L Convertible Bench | 4-5 | 29"x84" | 84"x12"x34" |
| CBG96 | 96"L Convertible Bench | 4-6 | 29"x96" | 96"x12"x34" |

| CORE | DESCRIPTION |
|------|---------------------------|
| MDF | Medium Density Fiberboard |
| PB | Particleboard |
| PW | Plywood |

| FRAME | DESCRIPTION |
|-------|--|
| PC | Textured Black Frame with Chromed Base |

QUICK SHIP CBG96-MDPEPCGYG
(Grey Nebula Back and Bench)

MODEL NUMBER CONFIGURATION

Model Number | Core | Edge | Frame | Back Laminate

CBG96-PW PE PC CH GY

Bench Laminate

BENCH/TABLE HEIGHTS

13"/25" code: 25 **15"/27"** code: 27 **17"/29"** standard **20"/32"** code: 32

*For non-standard heights add code to end of model number

Convertible Bench Design Options

Standard Edges

No minimum required



Vinyl T-Molding | Black (TM)



























Protect Edge | Black (PE)



3MM PVC Edge Banding | Black (EB)

Premium Edges

May be subject to minimum quantity and upcharge

| | | | | |
|-------------------------|---|---|--|---|
| VINYL T-MOLD |  |  |  |  |
| |  |  |  |  |
| |  |  |  |  |
| |  |  |  |  |
| 3MM PVC EDGE BANDING |  |  |  |  |
| |  |  |  |  |

Custom Logo Options

8 week lead time



Convertible Bench Design Options

Standard Laminates

No minimum required



Robin
RN



Port
PO



Regimental Red
RR



Hollyberry
RE



Candy Apple
CD



Orange Grove
OG



Marigold
YW



Teal Honeycomb
HC



Ocean
OC



Persian Blue
BL



Lapis Blue
LB



Catalina
CI



Indigo
IN



Atlantis
AT



Black
BK



Graphite Nebula
GN



Asian Night
AN



Rustic Slate
RS



Forged Steel
FS



Figured Mahogany
MY



Coffee Bean
CB



Mantana Walnut
WT



Lowell Ash
LA



Burnished Chestnut
CT



Buka Bark
KB



River Cherry
RC



Nepal Teak
NT



Wild Cherry
CH



Monticello Maple
MP



Bannister Oak
OK



Castle Oak
CO



Limber Maple
LM



Kensington Maple
KS



Fusion Maple
FM



Manitoba Maple
MT



Natural Tigris
NG



Natural Nebula
NN



Steel Mesh
SL



Slate Grey
SG



Mystic Night
MN



Pewter Brush
PB



Windswept Pewter
WP



Dove Grey
DG



Sheer Mesh
SM



Crisp Linen
CL



High Rise
HR



Frosty White
FW



White Sand
WS



Titanium EV
EV



Cloud Nebula
CN



Evening Tigris
ET



Bronze Legacy
BL



Nickel
NE



Pearl Soapstone
PS



Grey Glace
GG



Grey Nebula
GY



Platinum
PL



Fashion Grey
GF

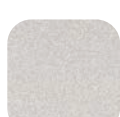

White Nebula
WN

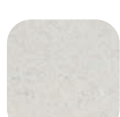

White Tigris
TW



Grey
RG

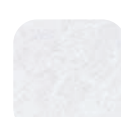

Grey Pampas
PP

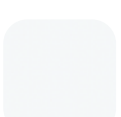

Designer White
DW

Convertible Bench Design Options



Premium Laminates

May be subject to minimum quantity and upcharge



**IF YOU DON'T SEE A
LAMINATE, JUST ASK!**

Choose any laminates from:

May be subject to minimum quantity and upcharge

